

BSMS - BSTS

AC WALL MOUNTED AXIAL FANS

Directly coupled motor. (single phase–three phase) 6 blades with concave blade system. Suitable for mounting on wall and window. Easy installation due to it's square plate.



- MATERIAL** : Housing is made of electrostatic powder coated sheet metal as square shaped, impeller is made of sheet metal with concave blade system.
- INSULATION CLASS** : Class B
- DIRECTIVE** : EN 60335-1, EN 60335-2-80
- SPEED CONTROL** : Speed can be adjusted using an optional controller.
- APPLICATION AREAS** : Factories, depots, dyehouses, shopping centers, workshops(plants) etc.

Technical Drawings

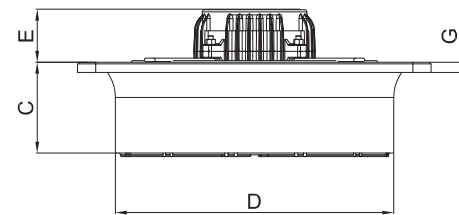
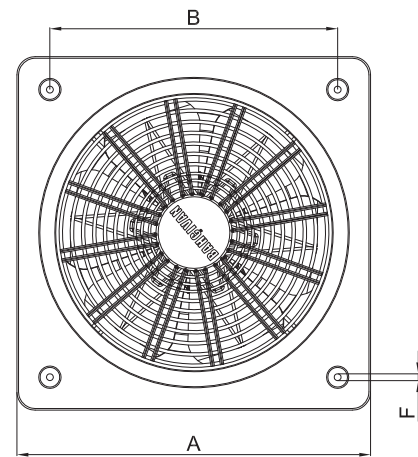

TYPE	VOLTAGE	FREQUENCY	POWER	CURRENT	CAPACITOR	SPEED	AIR FLOW	SOUND PRESSURE LEVEL	WEIGHT
	V	Hz	W	(A)	(μ F)	d/d	m ³ /h	dB(A)	kg
BSMS 250-2K/BSTS 250-2K	230/380	50	195	0,87	8/-	2900	2200	70	6.3
BSMS 250/BSTS 250	230/380	50	170	1,08	8/-	1465	1200	52	6
BSMS 300/BSTS 300	230/380	50	210	1,2	8/-	1400	2000	60	7
BSMS 350/BSTS 350	230/380	50	200	1,1	8/-	1400	3250	58	8.2
BSMS 400/BSTS 400	230/380	50	230	1,2	8/-	1420	4500	70	8.2
BSMS 450/BSTS 450	230/380	50	240	1,2	8/-	1385	5000	70	9.6
BSMS 500/BSTS 500	230/380	50	245	1,2	8/-	1335	5500	75	11
BSMS 550/BSTS 550	230/380	50	240	1	10	1350	6000	70	15.3
BSMS 600/BSTS 600	230/380	50	235	1	10	1370	8000	75	15.6

TYPE	A	B	C	D	E	F	G
BSMS 250-2K / BSTS 250-2K	333	275	80	261	80	8	10
BSMS 250 / BSTS 250	333	275	80	261	80	8	10
BSMS 300 / BSTS 300	412	336	80	307	80	8	10
BSMS 350 / BSTS 350	465	390	90	365	80	8	10
BSMS 400 / BSTS 400	500	420	100	403	80	8	10
BSMS 450 / BSTS 450	560	480	105	462	80	8	10
BSMS 500 / BSTS 500	630	561	110	513	90	8	10
BSMS 550 / BSTS 550	660	585	145	565	135	8	10
BSMS 600 / BSTS 600	700	631	145	612	135	8	10

Dimensions are in (mm)

AXIAL FANS

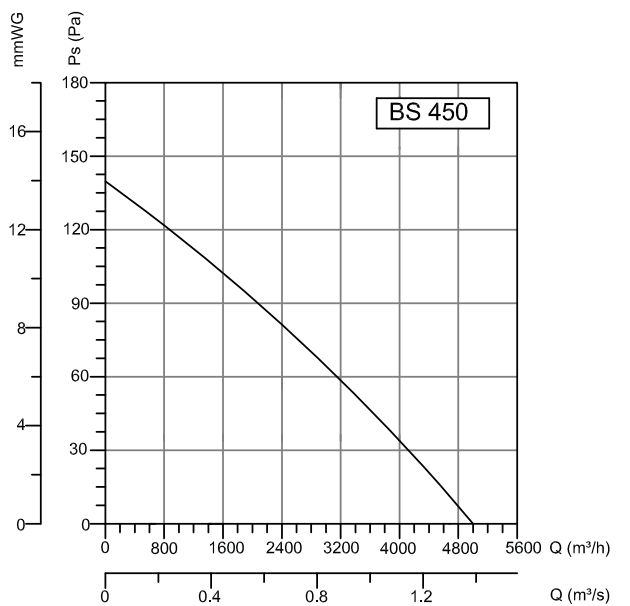
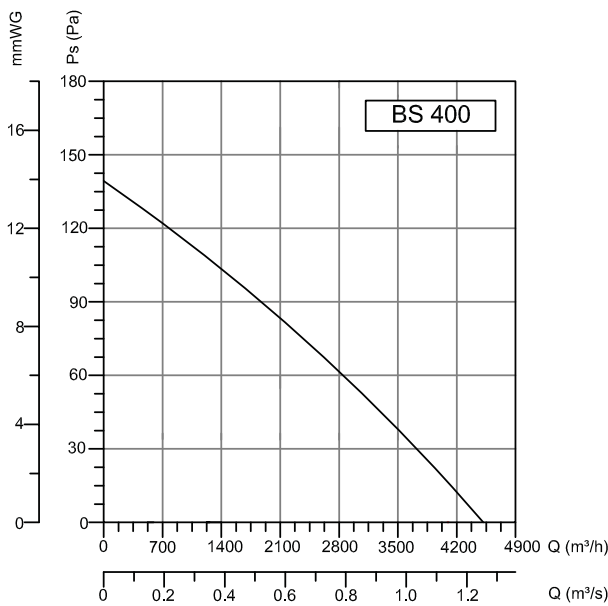
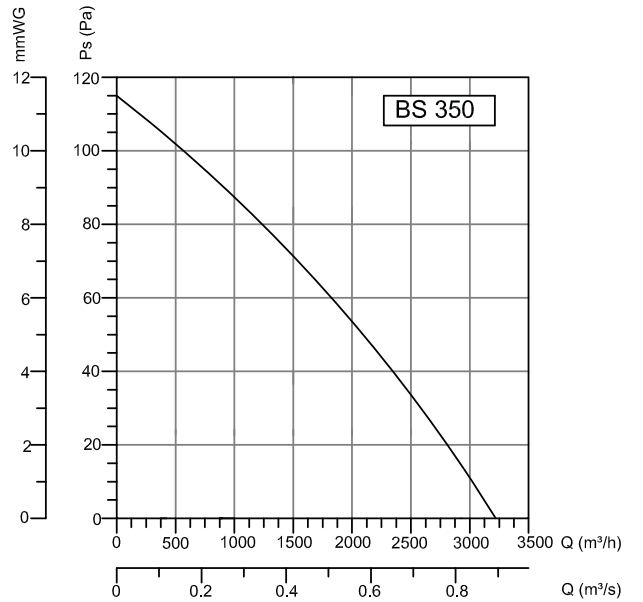
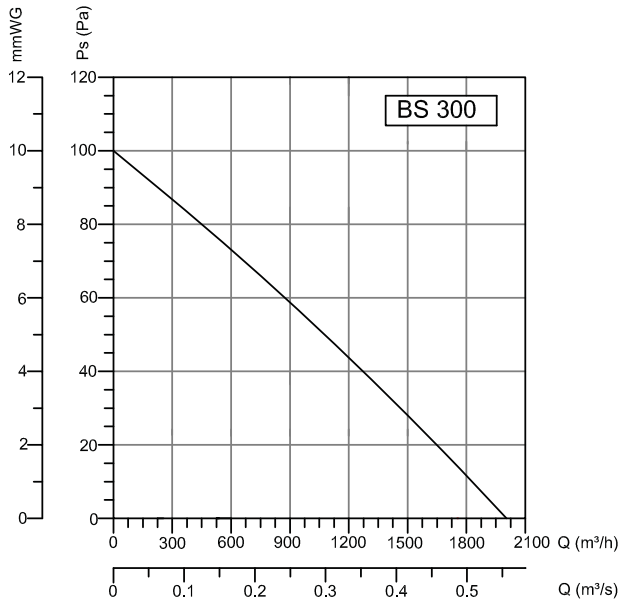
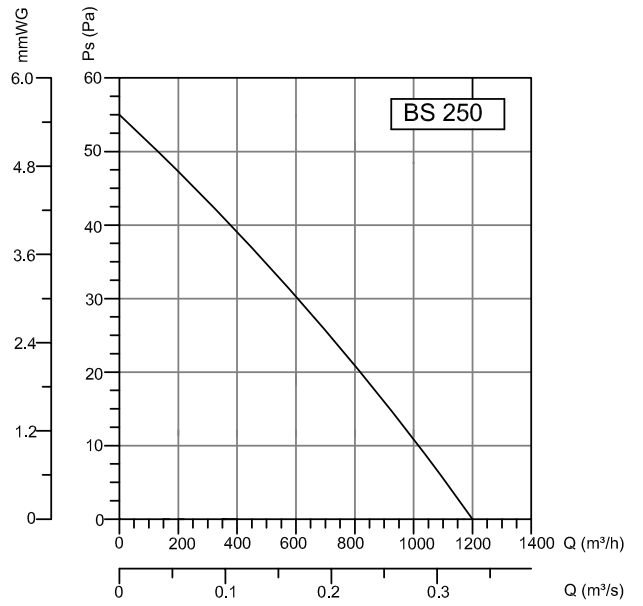
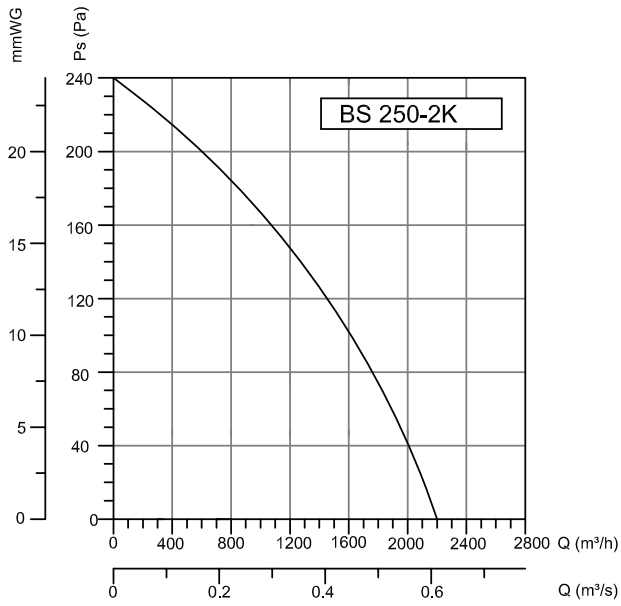

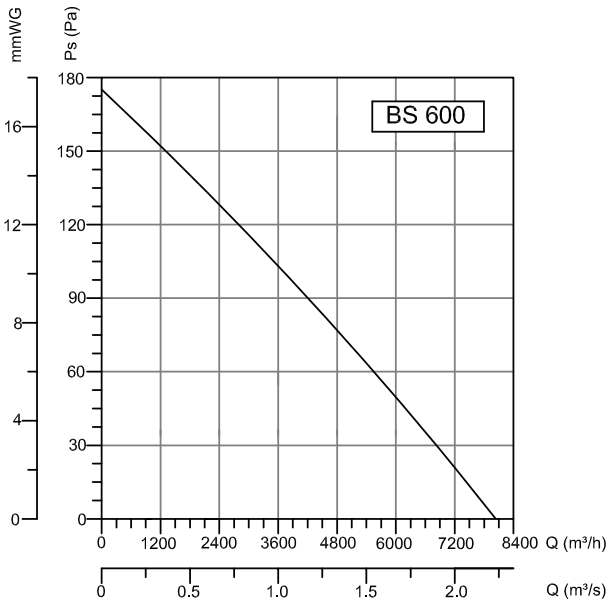
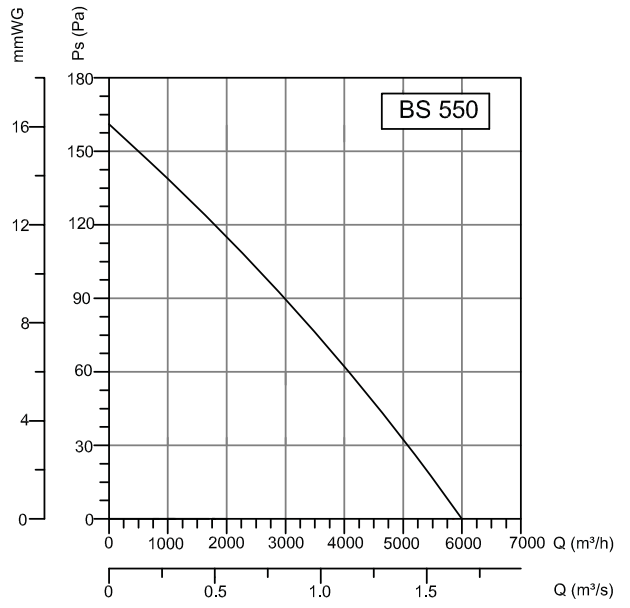
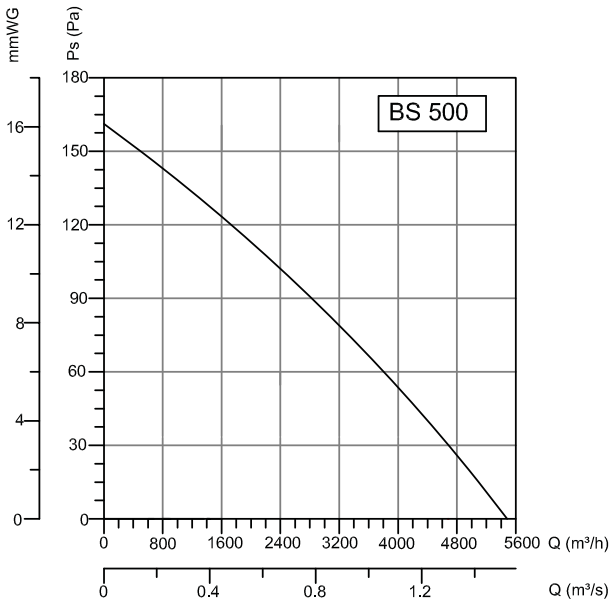

DUCT FANS

ROOF FANS

AXIAL FANS

RADIAL FANS

PLASTIC FANS

VENTILATORS

SMOKE EXHAUST SYSTEMS

ACCESSORIES